

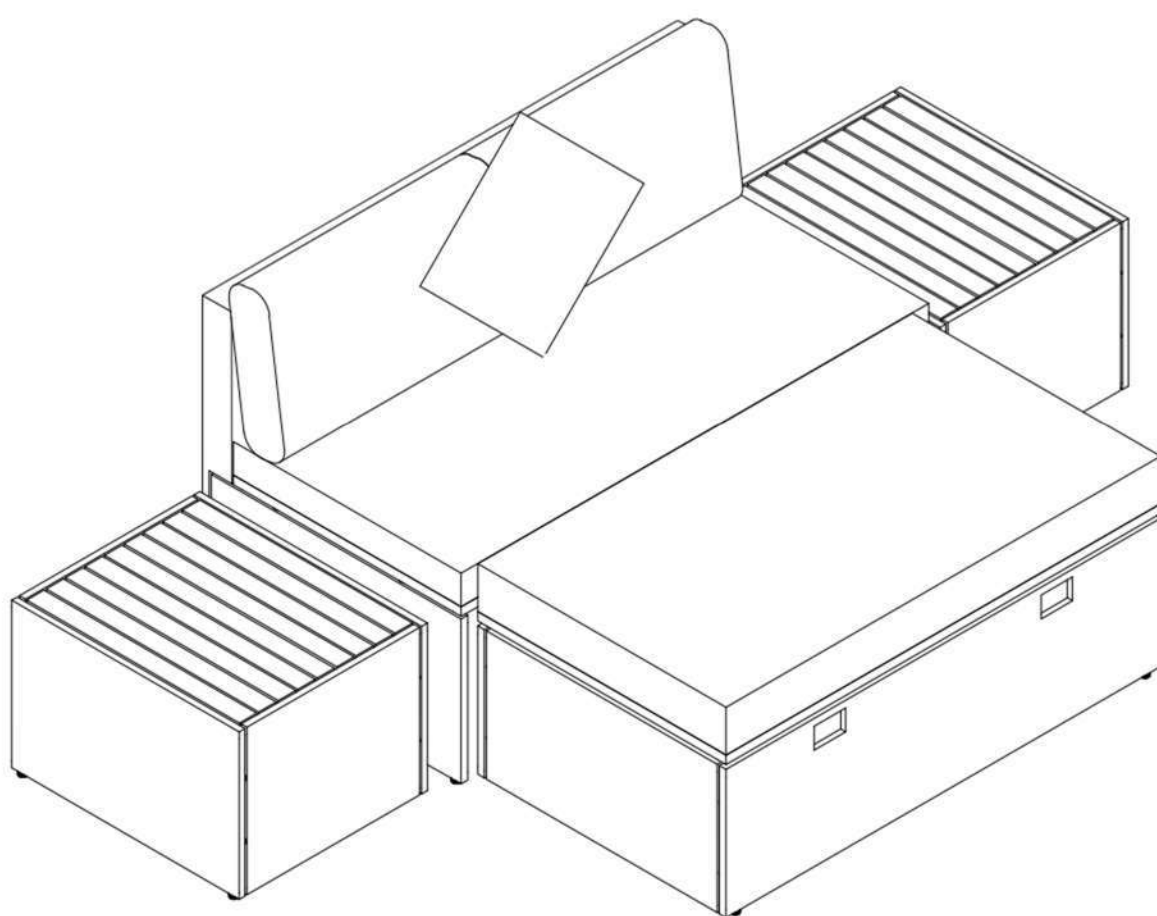

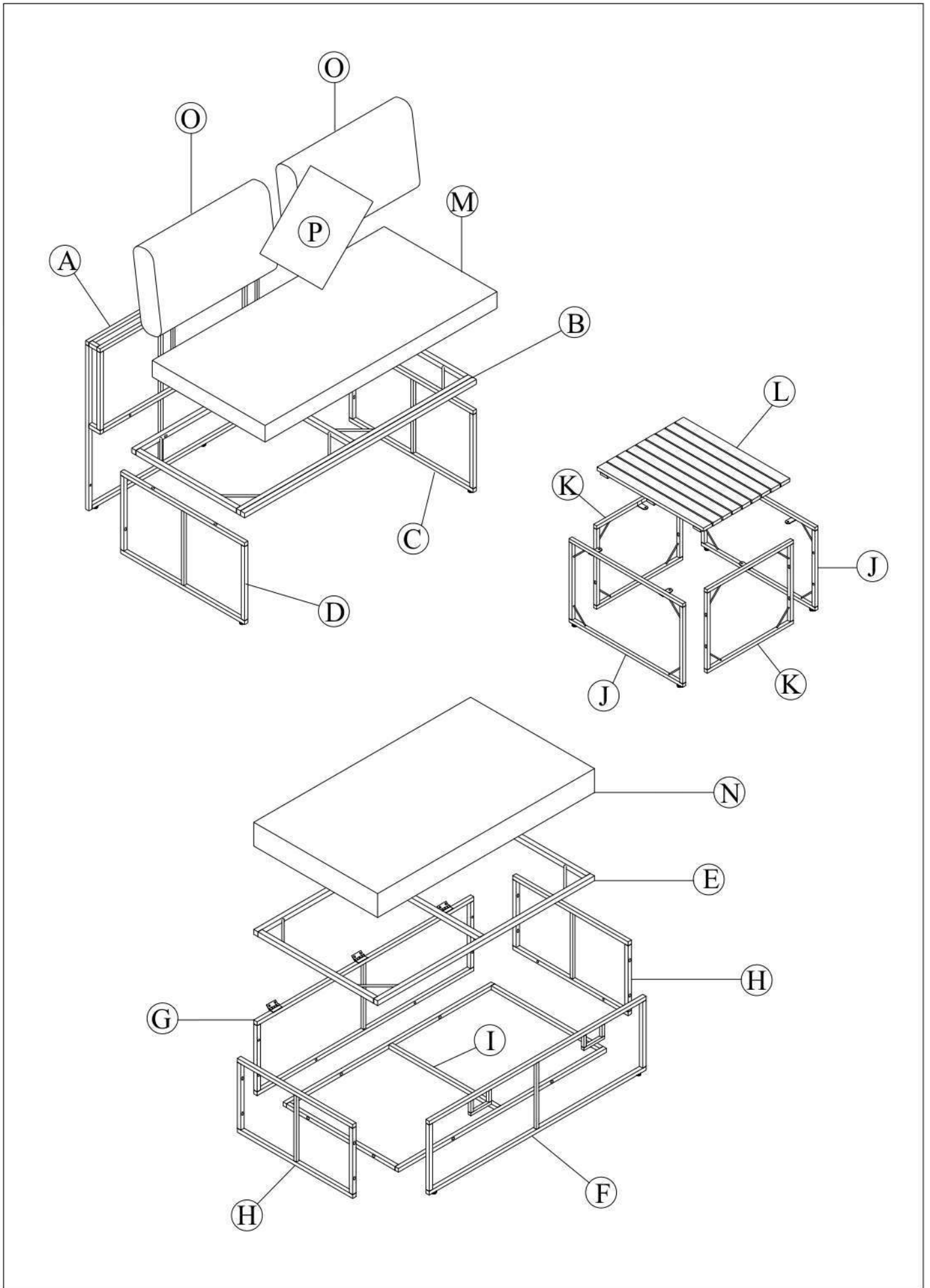

DEBRA

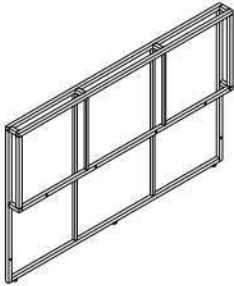
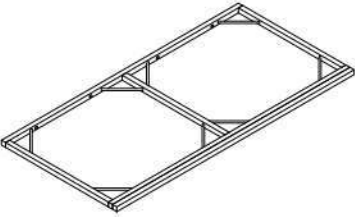
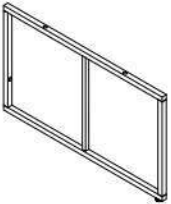
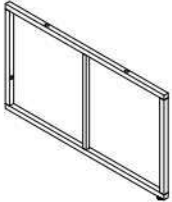
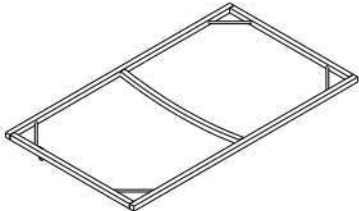
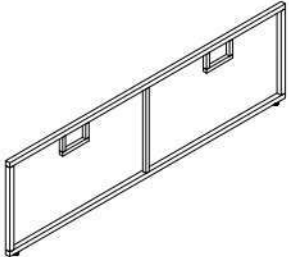
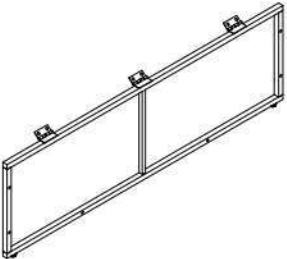

MGS-112414

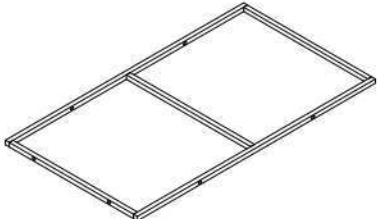
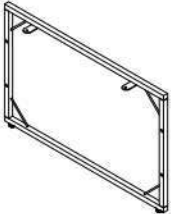
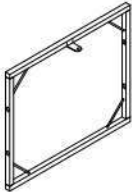

<p>A</p>  <p>1x</p>	<p>B</p>  <p>1x</p>	<p>C</p>  <p>1x</p>
<p>D</p>  <p>1x</p>	<p>E</p>  <p>1x</p>	<p>F</p>  <p>1x</p>
<p>G</p>  <p>1x</p>	<p>H</p>  <p>2x</p>	<p>I</p>  <p>1x</p>
<p>J</p>  <p>2x</p>	<p>K</p>  <p>2x</p>	<p>L</p>  <p>2x</p>

M

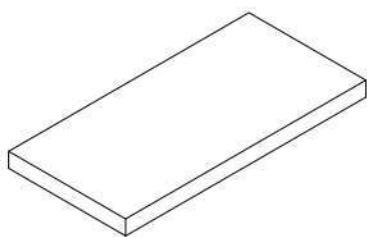

1x

N

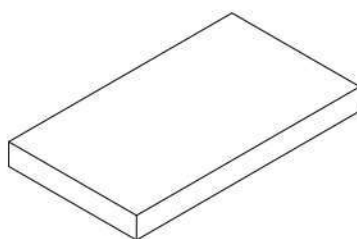

1x

O

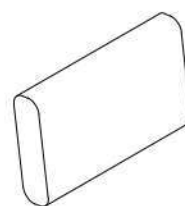





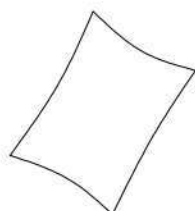



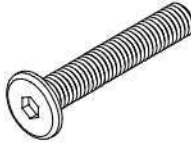
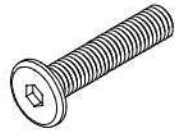

2x

P



1x

<p>1</p>  <p>M6 x 40 mm 4x</p>	<p>2</p>  <p>M6 x 35 mm 38x</p>	<p>3</p>  <p>M6 x 25 mm 2x</p>
<p>4</p>  <p>M6 x 15 mm 6x</p>	<p>5</p>  <p>M6 x 1 mm 46x</p>	<p>6</p>  <p>M6 x 5 mm 2x</p>
<p>7</p>  <p>1x</p>	<p>8</p>  <p>1x</p>	<p>9</p>  <p>8x</p>
<p>10</p>  <p>2x M4</p>	<p>11</p>  <p>1x</p>	

